

 **SENNHEISER**



PXC 360 BT

Instruction manual

Contents

Important safety instructions	2
PXC 360 BT	4
Delivery includes	6
Product overview	8
Putting the PXC 360 BT into operation	9
Charging the battery pack	9
Adjusting the headband	11
Switching the PXC 360 BT on/off	12
Connecting the PXC 360 BT to the audio source	13
Connecting the PXC 360 BT using the audio cable	16
Using the PXC 360 BT	17
Adjusting the PXC 360 BT to the listening situation	17
Changing the volume	18
Remote-controlling connected devices from the PXC 360 BT	19
Resetting the settings of the PXC 360 BT	20
Transporting the PXC 360 BT	21
Cleaning and maintaining the PXC 360 BT	22
If a problem occurs	23
Accessories	25
Specifications	26
apt-X audio coding	27
SRS WOW HD	29
Manufacturer Declarations	30

Important safety instructions

- Please read these instructions carefully and completely before using the product.
- Make these instructions easily accessible to all users at all times. Always include these instructions when passing the product on to third parties.
- Only use the product in aircraft where wireless **Bluetooth**[®] transmission is permitted.
- Do not use the product in situations which require special attention (e.g. in traffic or when performing skilled jobs).
- Always keep the product dry and do not expose it to extreme temperatures (normal operating temperatures: 0°C to 35°C).
- Use the product with care and store it in a clean, dust-free environment.
- Switch off the product after use to conserve battery power. Remove the batteries if the product will not be used for extended periods of time.
- The headphones contain magnets that generate a magnetic field which could cause interference with cardiac pacemakers and implanted defibrillators. Keep the headphones at least 1.2" (3 cm) from cardiac pacemakers or implanted defibrillators.
- Please protect your hearing from high volume levels. Sennheiser headphones also sound exceptionally good at low volumes.
- Only use the mains units and charging cables supplied by Sennheiser.
- To reduce the risk of fire or electric shock, do not use the product near water and do not expose it to rain or moisture.
- Unplug the mains unit from the wall socket
 - to completely disconnect the product from the mains
 - during lightning storms or
 - when unused for long periods of time.
- Only operate the mains unit from the type of power source specified in the chapter "Specifications" (see page 26).
- Ensure that the mains unit is
 - in a safe operating condition and easily accessible,
 - properly plugged into the wall socket,
 - only operated within the permissible temperature range,
 - not covered or exposed to direct sunlight for longer periods of time in order to prevent heat accumulation (see "Specifications" on page 26).
- Do not operate the product near any heat sources.
- Only use attachments/accessories specified by Sennheiser (see "Accessories" on page 25).

Intended use

Intended use includes:

- having read this instruction manual, especially the chapter “Important safety instructions” on page 2,
- using the product within the operating conditions and limitations described in this instruction manual.

“Improper use” means using the product other than as described in this instruction manual, or under operating conditions which differ from those described herein.















Safety instructions for the Lithium-Polymer battery pack

If abused or misused, the battery pack may leak. In extreme cases, it may even present



- a heat hazard,
- a fire hazard,
- an explosion hazard,
- a smoke or gas hazard.

Please understand that Sennheiser does not accept liability for damage arising from abuse or misuse.

	Keep away from children.		When not using the product for extended periods of time, remove the battery pack from the product.
	Immediately remove the battery pack from an obviously defective device.		Only use battery packs recommended by Sennheiser.
	Dispose of the battery pack at special collection points or return it to your specialist dealer.		Switch battery pack-powered products off after use.
	Only charge the battery pack with the appropriate Sennheiser chargers.		When not using the battery pack for extended periods of time, charge it regularly (about every 3 months).
	Only charge the battery pack at ambient temperatures between 10°C/50°F and 40°C/104°F.		Do not heat above 70°C/158°F, e.g. do not expose to sunlight or throw into a fire.
	Do not mutilate or dismantle.		Do not continue to use a defective battery pack.
	Do not short-circuit.		Do not expose to moisture.

PXC 360 BT

The PXC 360 BT headphones provide undisturbed music enjoyment in noisy environments – even without the constrictions of cables. Their circumaural, closed design and the latest active noise compensation technology (NoiseGard) make the PXC 360 BT especially suitable for use with in-flight entertainment systems. Due to their active and passive attenuation of ambient noise, they let you enjoy music even in noisy environments.

Bluetooth



The PXC 360 BT comply with the new **Bluetooth** 2.1 standard. Via their **Bluetooth** interface, they can be connected to a wide variety of **Bluetooth** enabled devices. **Bluetooth** wireless technology allows the PXC 360 BT to communicate with your **Bluetooth** enabled device (e.g. mobile phone, MP3 player, PC or PDA) within a range of up to 10 meters.

SRS WOW HD™



SRS WOW HD improves the dynamic audio performance of compressed and uncompressed audio by expanding the size of the audio image and creating a deep, rich bass response. The patented techniques in SRS WOW HD widen the horizontal sound field and raise the vertical sound image, retrieving information lost in the mixing process to create a more natural audio experience.

apt-X®



With apt-X audio coding, you can be assured of crisp, pure and full stereo sound. It allows you to not only hear, but experience and feel the audio as it was intended. Utilizing apt-X, **Bluetooth** technology can now offer wireless audio quality that is indistinguishable from the highest quality wired connection.

From major public broadcasters to film production studios, apt-X is used throughout the world to transmit high quality digital audio from A to Z in real-time. It was developed to meet the exacting standards of musicians and audio engineers who love the exceptional dynamic range and high fidelity it provides.

Now available on selected consumer devices, the apt-X technology ensures that music lovers everywhere can stream the rich listening experience that only apt-X can deliver.



NoiseGard™

The NoiseGard active noise compensation system is based on the principle of cancelling out sound using “anti-sound” (phase-inverted sound). Tiny microphones pick up low-frequency ambient noise (up to 1 kHz) near the ear. The NoiseGard electronics use this noise to generate a sound wave which is the exact opposite (IE: at the same level but polarity reversed – 180° out-of-phase), the effect being that the polarity reversed signal cancels most of the outside noise.

TalkThrough

The PXC 360 BT headphones have a TalkThrough function, which allows you to communicate with other people without having to remove the headphones. When TalkThrough is activated, professional quality microphones mounted on the outside of the headphones pick up all acoustic signals in the immediate vicinity. Annoying background noise is electronically filtered out, only allowing the voice of the other person to pass through the headphones clearly.

Additional features



- Great for travel: comfortable, rugged and foldable headphone construction
- Optional connection via audio cable for music enjoyment without Bluetooth technology
- Outstanding sound quality due to Duofol diaphragms
- Optimum protection against ambient noise due to active and passive noise attenuation

Delivery includes





- 1 PXC 360 BT headphones
- 1 BA 370 PX battery pack
- 1 USB charging cable
- 1 mains unit with country adapters
- 1 stereo audio cable
(2.5 mm to 3.5 mm jack plug)
- 1 audio adapter
(3.5 mm jack socket to ¼" (6.35 mm) jack plug)
- 1 in-flight adapter
(3.5 mm jack socket to 3.5 mm double mono jack plug)
- 1 transport case
- 1 quick start guide incl. CD ROM with detailed instruction manual as PDF
- 1 safety guide

Overview of the pictograms





Meaning of the pictograms for pressing a button

Pictogram	Meaning
	Briefly press this button.
	Keep this button pressed for 4 seconds.
	Keep this button pressed until the desired setting is made or the desired action is completed.

Meaning of the pictograms for the flashing of the LED

Pictogram	Meaning
	This pictogram symbolizes a flashing.
	This pictogram symbolizes an interruption.
	This pictogram symbolizes an interval.
	This pictogram symbolizes a continuous flashing.

Examples of some of the pictograms that are used throughout this instruction manual:

Pictogram	Meaning
	The LED flashes once every 3 seconds.
	The LED flashes 3 times per second.
	The LED flashes in a rhythmic sequence.
	The LED flashes blue 3 times and then goes off.

The pictogram "i"



This note provides important information!

Notes marked with the pictogram "i" provide important information on the use of the headphones.

Product overview

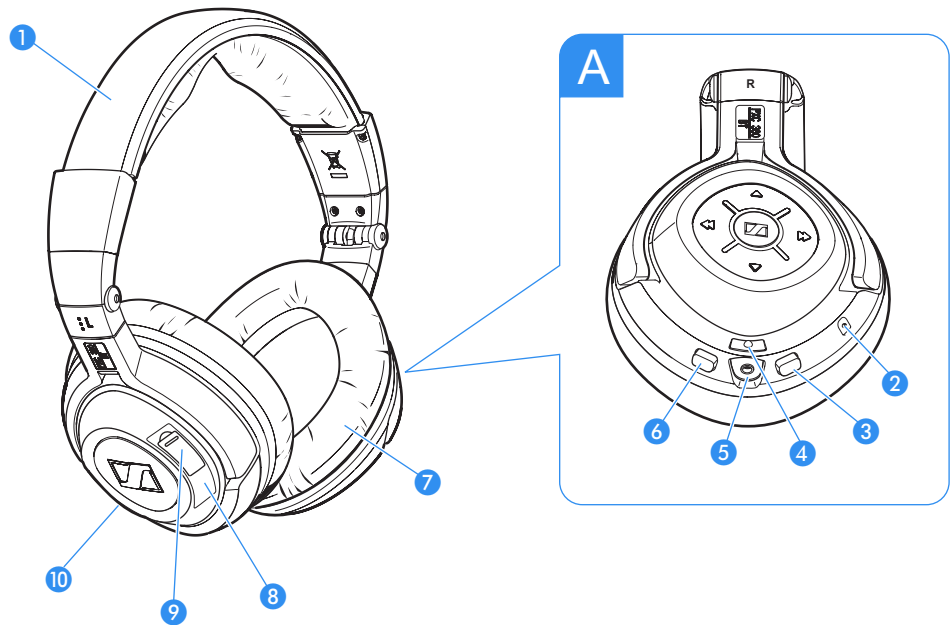

- ① Headband
- ② Microphone
- ③ NoiseGard button
- ④ SRS button
- ⑤ Socket for audio cable
- ⑥ Bluetooth button
- ⑦ Ear pad
- ⑧ Battery pack compartment
- ⑨ Socket for charging cable
- ⑩ Microphone

A Operating panel

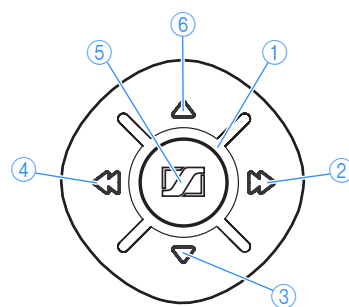

- ① LED
- ② Fast-forward button
- ③ Volume down button
- ④ Rewind button
- ⑤ Master button
- ⑥ Volume up button

Putting the PXC 360 BT into operation

- ▶ Before using the PXC 360 BT for the first time, remove the protection strip from the battery pack.

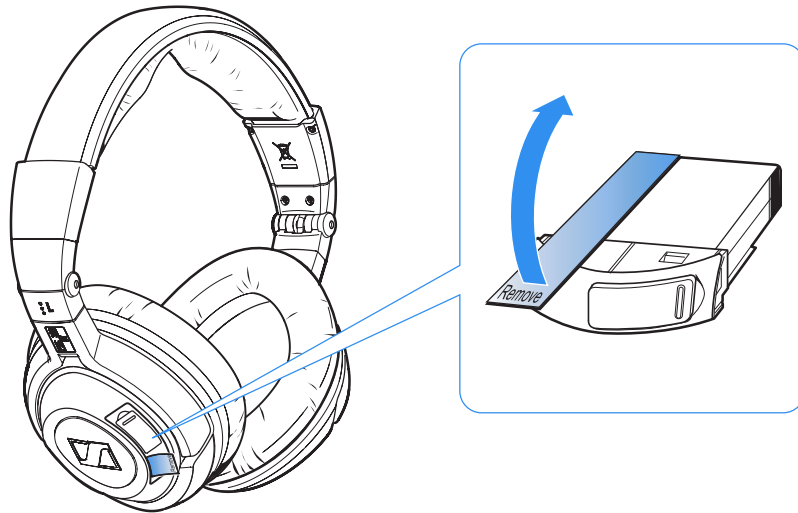

Charging the battery pack



- ▶ Before using the battery pack for the first time, charge it for at least 3 hours. The battery pack can also be charged inside the headphones during operation.

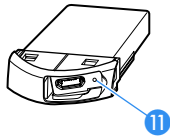

When charging the battery pack, the LED ⑪ on the battery pack lights up red. When the battery pack is fully charged, the LED ⑪ on the battery pack lights up green.



When the battery pack is almost flat, the  LED ① flashes red. You hear a short, descending acknowledgement tone.

The operating time of the battery pack depends on the device settings, the listening situation and the audio sources used. The operating time will be reduced if you use SRS WOW HD.

Type of use	Operating time
NoiseGard and Bluetooth technology	8 hours
NoiseGard without Bluetooth technology	20 hours
Bluetooth technology without NoiseGard	10 hours

-  Remove the battery pack if the headphones will not be used for extended periods of time.

Possibilities of charging the battery pack

First, connect the charging cable 12 to the battery pack as described in section a and then connect the charging cable 12 to a power source as described in section b.

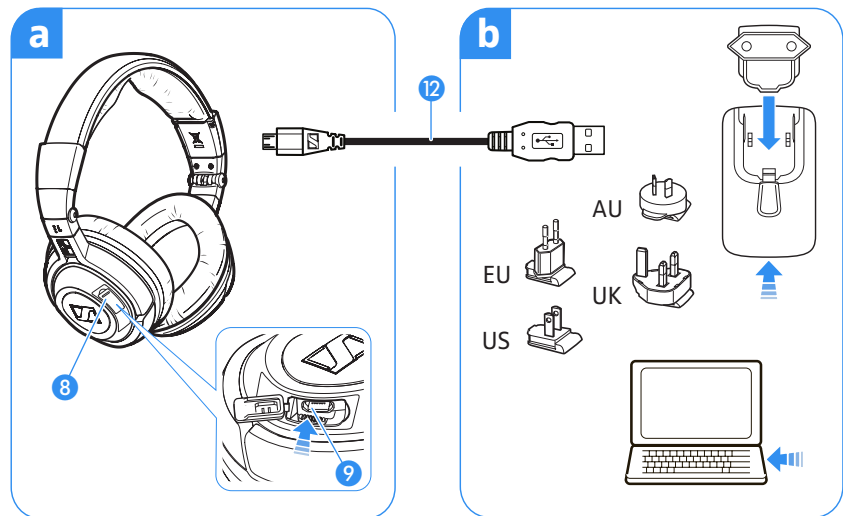

a Connecting the charging cable to the battery pack

You can charge the battery pack either inside or outside the headphones. This is helpful if you are using a spare battery pack (to be ordered separately).

To charge the battery pack **inside** the headphones:

- ▶ Open the cover of the battery pack compartment 8 on the left ear cup.
- ▶ Connect the charging cable 12 to the socket for charging cable 9 on the headphones.

To charge the battery pack **outside** the headphones:

- ▶ Open the cover of the battery pack compartment 8 on the left ear cup.
- ▶ Press the button next to the battery pack compartment and remove the battery pack.

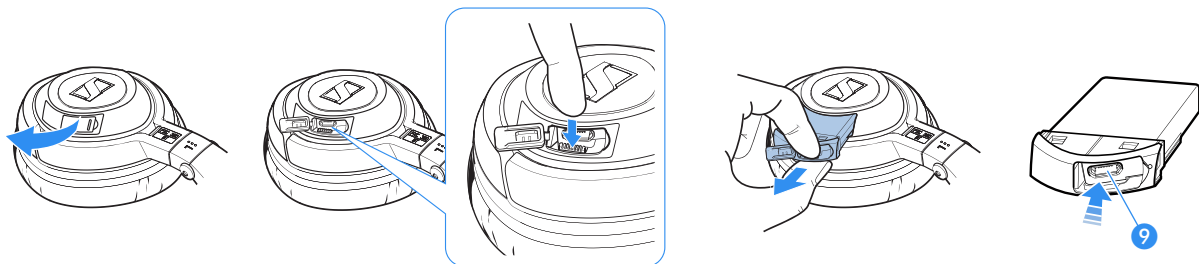

- ▶ Connect the charging cable 12 to the socket for charging cable 9 on the battery pack.

b Connecting the charging cable to the mains unit, to a PC or to other USB devices

In order to charge the battery pack, you can connect the charging cable to either the USB socket of your PC or the supplied mains unit or to other USB devices.

To connect the charging cable **to a PC**:

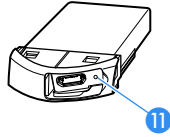

- ▶ Connect the USB plug of the charging cable (12) to the USB socket of your PC.
The battery pack is being charged. The LED (11) on the battery pack lights up red.

To connect the charging cable **to the mains unit**:

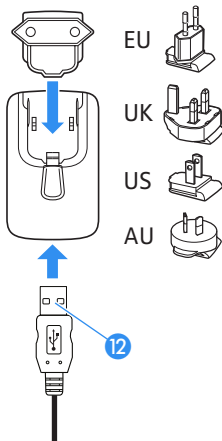

- ▶ Connect the charging cable (12) to the mains unit.
- ▶ Plug the suitable country adapter onto the mains unit.
- ▶ Plug the mains unit into a wall socket.
The battery pack is being charged. The LED (11) on the battery pack lights up red.
- ▶ After charging, unplug the mains unit from the wall socket.

If you have charged the battery pack **outside** the headphones:

- ▶ Insert the charged battery pack into the headphone's battery pack compartment until it locks into place.
- ▶ Close the cover of the battery pack compartment (8).

Adjusting the headband

For optimum transmission quality, good noise attenuation and best possible comfort, the headband has to be adjusted to properly fit your head:

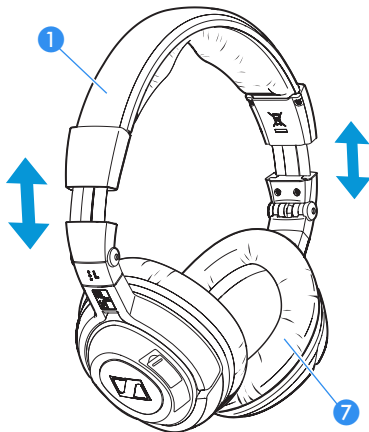

- ▶ Wear the headphones so that the headband (1) runs over the top of your head.
- ▶ Adjust the length of the headband so that
 - the ear pads (7) rest comfortably against the ears,
 - you feel even, gentle pressure around your ears,
 - a snug fit of the headband (1) on the head is ensured.
- ▶ To ensure maximum noise attenuation, final adjustment is best made in a noisy environment.

Switching the PXC 360 BT on/off

CAUTION Hearing damage due to high volumes!



Listening at high volume levels for long periods can lead to permanent hearing defects.

- ▶ Before putting the headphones on, set the volume to a low level.
- ▶ Do not continuously expose yourself to high volumes.

Switching the PXC 360 BT on

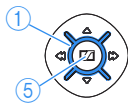

- ▶ Press the **Master** button ⑤ and keep it pressed until the LED ① flashes blue. You hear an ascending beep.
 - When switching the headphones on **for the first time**, it will automatically go into pairing mode. The headphones are waiting to be paired with a **Bluetooth** enabled device (see page 13).
 - When the headphones **are already paired with an audio source**, the **Bluetooth** connection is automatically established. You hear an ascending beep and then you hear your audio source.
 - When the headphones **are already paired with an audio source** but the **audio source** is **switched off** or out of range, the LED ① flashes blue. The headphones will try for 3 minutes to connect to one of the up to 8 previously paired audio sources. If this fails, the headphones automatically switch off after 60 minutes.

Switching the PXC360 BT off

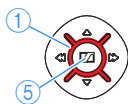

- ▶ Press the **Master** button ⑤ and keep it pressed until the LED ① flashes 3 times red. You hear a descending beep. The **Bluetooth** connection is automatically deactivated. The headphones switch off.

Connecting the PXC 360 BT to the audio source

CAUTION Danger of malfunction!

The transmitted radio waves can impair the operation of sensitive and unprotected devices.

- ▶ Only use the headphones in aircraft where wireless **Bluetooth** transmission is permitted or use the audio cable instead (see "Connecting the PXC 360 BT using the audio cable" on page 16).
-

The headphones comply with the **Bluetooth** 2.1 standard. In order that data can be transmitted wirelessly using **Bluetooth** technology, you have to register your headphones with your audio source (pairing).

The headphones can save the connection profiles of up to 8 **Bluetooth** devices with which they have been paired. After switch-on, the headphones automatically connect to one of these devices.

If you pair the headphones with a ninth audio source, the saved connection profile of the first **Bluetooth** device will be overwritten. If you want to re-establish a connection with the first audio source, you have to pair the headphones with this audio source again.

If your audio source does not have a **Bluetooth** interface, use an optional dongle (see "Accessories" on page 25). In addition to adding **Bluetooth** capability to your audio source, this dongle uses apt-X, a technology that ensures crisp, pure and full stereo sound. With apt-X, **Bluetooth** can now offer wireless audio quality that is indistinguishable from the highest quality wired connection.



A connection to the headphones is only possible if your audio source supports the A2DP profile.

Pairing the PXC 360 BT with your audio source

 ▶ Make sure that your headphones are switched off (see “Switching the PXC 360 BT on/off” on page 12).

When switching the headphones on **for the first time**, they will automatically go into pairing mode. The headphones are waiting to be paired with a **Bluetooth** enabled device (see page 13).



▶ Press the **Master** button (5) and keep it pressed until the LED (1) alternately flashes blue and red.

▶ On your audio source, activate the **Bluetooth** function “Add a new device”.

▶ Proceed as described in the instruction manual of the audio source.



If a suitable audio source is found, the devices will exchange device identification information. The LED (1) flashes 3 times blue and you hear an ascending beep. The devices have identified each other and the headphones are paired with the audio source.

 **PIN code**
When the audio source prompts for a password or PIN code, enter the default PIN code “0000”.



If a connection is established, the LED (1) continues to slowly flash blue.



If no device is found within approx. 5 minutes, the LED (1) flashes 3 times red and you hear a descending beep. The headphones will then try for 3 minutes to connect to one of the up to 8 previously paired audio sources. If this fails, the headphones automatically switch off after 60 minutes.

▶ In this case, repeat the necessary steps to pair the headphones with your audio source again.

Switching the “Bluetooth connection” flashing on/off

▶ Switch the headphones off (see “Switching the PXC 360 BT on/off” on page 12).

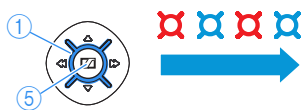

To switch the flashing **on** during a **Bluetooth** connection:

▶ Press the **Master** button (5) and keep it pressed until the LED (1) alternately flashes blue and red.

▶ Briefly press the Volume ▲ button (6).

To switch the flashing **off** during a **Bluetooth** connection:

▶ Briefly press the Volume ▼ button (3).

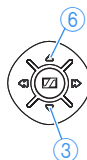

Disconnecting the Bluetooth connection



The **Bluetooth** button ⑥ is backlit, indicating the current setting. The backlighting goes off after a short time to conserve energy.

- ▶ Press any button on the headphones to display the current setting of the **Bluetooth** function.

To disconnect the **Bluetooth** connection to the audio source, you can switch off the headphones or the **Bluetooth** function. This setting is retained until the **Bluetooth** function is switched on again.

To switch the headphones off:

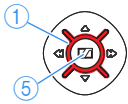

- ▶ Press the **Master** button ⑤ and keep it pressed until the **LED** ① flashes 3 times red. You hear a descending beep. The **Bluetooth** connection is automatically deactivated. The headphones switch off.

To switch the **Bluetooth** function off:



- ▶ Press the **Bluetooth** button ⑥ and keep it pressed until the **LED** ① flashes 3 times red. You hear a descending beep. The **Bluetooth** button ⑥ goes off. The **Bluetooth** function is switched off.

Connecting the PXC 360 BT using the audio cable



Connecting the audio cable

You can connect the headphones to the audio source using the audio cable if:

- you do not want to use the **Bluetooth** function,
- you are not allowed to use the **Bluetooth** function (some airlines do not allow **Bluetooth** transmission)
or
- the battery pack is flat.



 When the audio cable is connected to the headphones, the **Bluetooth** function cannot be switched on.



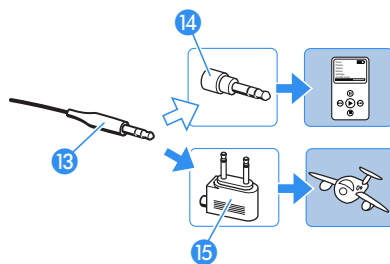

If the headphones are already connected to the audio source via the **Bluetooth** interface, the **Bluetooth** connection is automatically disconnected when you connect the audio cable. The  LED  flashes 3 times red and you hear a descending beep.

▶ Connect the 2.5 mm jack plug of the audio cable to the socket  of the headphones.





- ▶ Connect the 3.5 mm jack plug of the audio cable  to
- the headphone socket of your audio source or
 - the audio adapter for 1/4" (6.35 mm) jack socket  if the 3.5 mm jack plug of the audio cable is too small
 - the in-flight adapter  if you want to use the headphones with an in-flight entertainment system.



When the audio cable is connected to your audio source, you hear the sound from your audio source and the  LED  flashes blue.

Detaching the audio cable

If you want to use the PXC 360 BT as **Bluetooth** headphones only, you can detach the audio cable .

▶ Pull the 2.5 mm jack plug of the audio cable  from the socket  of the headphones.

 When detaching the audio cable, the **Bluetooth** function is not automatically switched on.

- ▶ Switch the **Bluetooth** function on again (see "Switching the **Bluetooth** function on/off" on page 18).

Using the PXC 360 BT

Adjusting the PXC 360 BT to the listening situation

The headphones have a SRS WOW HD function, a NoiseGard function, a Bluetooth function and a TalkThrough function. Depending on the listening situation, you can switch these functions on or off.

Switching the SRS WOW HD function on/off

SRS WOW HD ensures enhanced sound quality and bass boost performance, thus allowing for a spectacular sound experience.

To switch the SRS WOW HD sound enhancement on:



- ▶ Briefly press the **SRS** button **4**.
The button is backlit in yellow and the SRS WOW HD function is switched on.

To switch the SRS WOW HD sound enhancement off:

- ▶ Briefly press the **SRS** button **4**.
The yellow backlighting goes off and the SRS WOW HD function is switched off.

Switching the NoiseGard function on/off



The **NoiseGard** button **3** is backlit, indicating the current setting. The backlighting goes off after a short while in order to conserve energy.



- ▶ Press any button on the headphones to display the current setting of the NoiseGard active noise compensation.

The NoiseGard function has to be switched on to be active. If the NoiseGard function is switched off, the PXC 360 BT can also be used as conventional headphones.

To switch the NoiseGard function on:



- Press the **NoiseGard** button **3** for 2 seconds.
The button is backlit in red and the NoiseGard function is switched on.

To switch the NoiseGard function off:

- Press the **NoiseGard** button **3** for 2 seconds.
The red backlighting goes off and the NoiseGard function is switched off.



Conserving energy

Switch the NoiseGard function off after use to conserve energy.

Switching the TalkThrough function on/off

The PXC 360 BT provide excellent attenuation of ambient noise. The Talk-Through function allows you to communicate undisturbed with other people without having to remove the headphones even when NoiseGard is switched on.

To switch the TalkThrough function on:



- ▶ Briefly press the **NoiseGard** button **3**.
The **LED 1** lights up red. The TalkThrough function is switched on.

To switch the TalkThrough function off:

- ▶ Briefly press the **NoiseGard** button **3**.
The **LED 1** goes off. The TalkThrough function is switched off.



When the TalkThrough function is switched on, you cannot listen to music.

Switching the Bluetooth function on/off

Via the **Bluetooth** interface, the headphones can be connected to a wide variety of **Bluetooth** enabled devices.

To switch the **Bluetooth** function on:



- ▶ Press the **Bluetooth** button **6** and keep it pressed until the **LED 1** flashes 3 times blue. The **Bluetooth** function is switched on.

To switch the **Bluetooth** function off:

- ▶ Press the **Bluetooth** button **6** and keep it pressed until the **LED 1** flashes 3 times red. You hear a descending beep.
The **Bluetooth** button **6** goes off. The **LED 1** flashes blue and the **Bluetooth** function is switched off.

Changing the volume

The PXC 360 BT allow you to change the volume of the audio signal:

Button	Duration	Function	Button	Duration	Function
		Incrementally increases the volume			Incrementally reduces the volume
		Continuously increases the volume			Continuously reduces the volume

If you press the respective button briefly, the volume is changed incrementally; if you hold down the button, the volume is changed continuously.

When the minimum or maximum volume is reached, you hear an acknowledgement tone.





















Remote-controlling connected devices from the PXC 360 BT

You can directly remote-control any device supporting the AVRCP profile and connected to the PXC 360 BT by using the buttons on the headphones. Please refer to the instruction manual of your audio source for information on whether your device supports the AVRCP profile.

If your device does not support the AVRCP profile, you can use an optional dongle. Using the iPod dongle or the USB dongle, you can remote-control the connected devices from the headphones.

Remote-controlling the audio source from the PXC 360 BT

If your headphones have a **Bluetooth** connection to an audio source (e.g. iPod, MP3 or CD player), you can use the PXC 360 BT to remote-control the audio source as follows:

Button	Duration	Function	Button	Duration	Function
		Incrementally increases the volume			Incrementally reduces the volume
		Continuously increases the volume			Continuously reduces the volume
		Skips to the next track			Skips to the previous track
		Fast-forwards the track *			Rewinds the track *
		Plays the track			Stops the track (acknowledgement tone)

* These functions are not supported by all connected **Bluetooth** devices.

Resetting the settings of the PXC 360 BT

You can reset all settings of your headphones to the factory default settings. This allows you to prevent that other users of the headphones can access your **Bluetooth** enabled devices. You can then pair 8 new devices with the headphones.

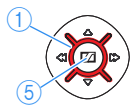

- ▶ Press the **Master** button (5) and keep it pressed until the **LED** (1) flashes 3 times red. The headphones switch off (see "Switching the PXC 360 BT on/off" on page 12).

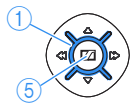

- ▶ Press the **Master** button (5) and keep it pressed until the **LED** (1) alternately flashes blue and red.



- ▶ Press the **Bluetooth** button (6) and keep it pressed until the settings of the headphones are reset.

Transporting the PXC 360 BT

For space-saving transportation, the headphones can be folded up **flatly** and **compactly**.

- ▶ Rotate the ear cups by 90°.
- ▶ Fold the ear cups inwards.
- ▶ Place the headphones flat into the transport case.

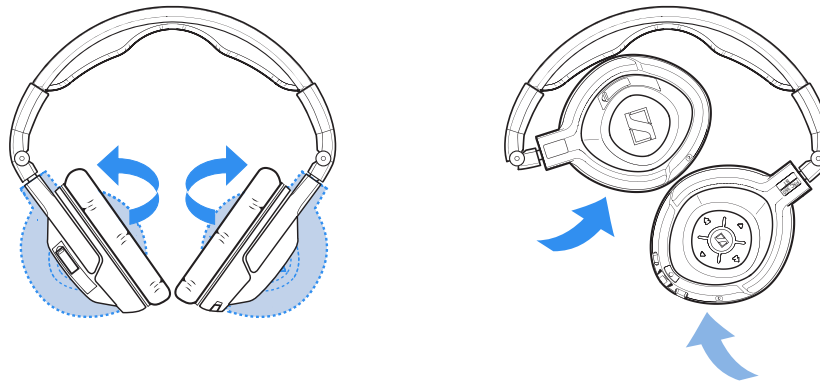

Your accessories can be transported in the transport case:

- Audio adapter (1/4" (6.35 mm) jack plug)
- In-flight adapter (3.5 mm double mono jack)

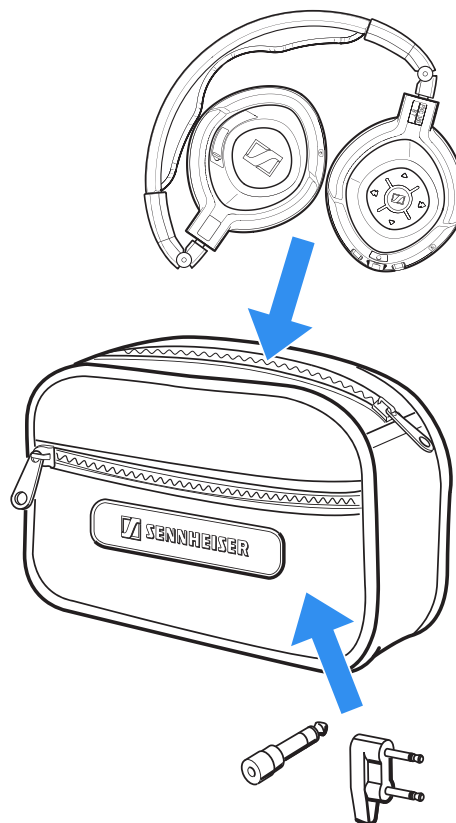

Cleaning and maintaining the PXC 360 BT

Cleaning the PXC 360 BT

CAUTION Liquids can damage the electronics of the product!

Liquids entering the housing of the product can cause a short-circuit and damage the electronics.

- ▶ Keep all liquids far away from the device.
 - ▶ Do not use any solvents or cleansing agents.
-

For reasons of hygiene, you should clean the headphones regularly:

- ▶ Before cleaning, make sure that the headphones are not recharged via the mains.
- ▶ Only use a dry and soft cloth to clean the product.

Replacing the ear pads

You can replace the ear pads. Spare ear pads are available from your Sennheiser partner or can be ordered at www.sennheiser.com under "Service & Support".

- ▶ Grasp the edge of the ear pad ⑦ behind the ear cup and peel it up and away from the ear cup.
- ▶ Slide the new ear pad ⑦ onto the ear cup.

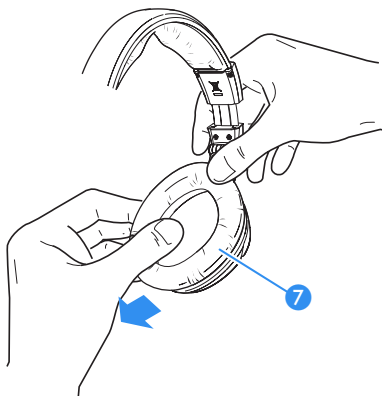

If a problem occurs ...

Problem	Possible cause	Solution	Page
No operation indicator – headphones cannot be switched on	The battery pack is flat.	Recharge the battery pack.	9
No audio signal when the audio cable is connected	The jack plug of the audio cable is not properly connected.	Check the connection to your audio source.	16
No audio signal during Bluetooth connection	The headphones are switched off.	Switch the headphones on.	12
	The headphones are not paired with an audio source.	Check if the headphones are paired. If necessary, pair the headphones with the audio source again.	13
	The Bluetooth function on the headphones is switched off.	Switch the Bluetooth function on the headphones on.	18
	The audio cable is connected to the headphones.	The connection of the audio cable automatically switches off the Bluetooth connection. Remove the audio cable and then switch the Bluetooth function on again.	16
	The volume is adjusted too low.	Increase the volume.	18
Headphones cannot be paired	The pairing does not work.	Check if the audio source supports the A2DP profile. If not, use one of the optional dongles.	–
	The audio source is switched off.	Switch the audio source on.	13
No audio signal during NoiseGard operation	The headphones are switched off.	Switch the headphones on.	12
	The TalkThrough function is switched on. When in Talk-Through mode, the audio signal is not available.	Switch the TalkThrough function off.	18

Problem	Possible cause	Solution	Page
Headphones do not react to any button press	The operation of the headphones is faulty.	Remove the battery pack from the headphones. Reinsert the battery pack into the headphones. Switch the headphones on again.	–
Bluetooth connection is suddenly interrupted	The Bluetooth button has been pressed too long.	Switch the Bluetooth function on.	18

If a problem occurs that is not listed in the above table or if the problem cannot be solved with the proposed solutions, please contact your Sennheiser partner for assistance.

To find a Sennheiser partner in your country, search at www.sennheiser.com.

Accessories

Cat. No.	Accessory
540364	Ear pads, 1 pair
540363	Headband padding, 1 pair
525776	PSC 03R-050 mains unit with 4 country adapters (EU/UK/US/AUS)
531406	Stereo audio cable (2.5 mm jack plug to 3.5 mm jack plug)
088526	In-flight adapter (3.5 mm jack socket to 3.5 mm double mono jack plug)
077046	Audio adapter (3.5 mm jack socket to 1/4" (6.35 mm) jack plug)
531407	USB cable (microUSB to USB)
535105	BA 370 PX battery pack
502388	BTD 300 Audio
502390	BTD 300 USB
502389	BTD 300i

Specifications

Transducer principle	dynamic, closed
Ear coupling	circumaural
Frequency response	15–22,000 Hz
Nominal impedance active/passive	590/100 Ω
Sound pressure level at 1 kHz and 1 Volt	107 dB SPL
THD at 1 kHz	< 0.1%
Audio connection	3.5 mm stereo jack socket
Audio adapter	¼" (6.35 mm) stereo jack plug
In-flight adapter	3.5 mm double mono jack plug
Cable length	
Audio cable	1.4 m
Charging cable	0.8 m
Weight	179 g
BA 370 PX battery pack	3.7 V; 250 mAh Lithium-Polymer
Charging time	3 hrs
Operating time	8 hrs/10 hrs/20 hrs
Operating temperature range	0°C to +40°C
Storage temperature range	–10°C to +70°C
Passive noise attenuation	25 dB
NoiseGard active noise compensation	23 dB

PSC 03R-050 mains unit

Nominal input voltage	110–240 V~
Nominal input current	max. 0.2 A
Mains frequency	50–60 Hz
Nominal output voltage	5 V ---
Nominal output current	max. 0.5 A
Operating temperature range	0°C to +45°C
Storage temperature range	–40°C to +85°C
Relative humidity	20 to 90%
Weight	approx. 61 g

Bluetooth



Bluetooth®	version 2.1 + EDR
Range	up to 10 m
Transmission frequency	2.4 GHz
Transmission power	8 dBm
Profiles	A2DP, AVRCP
Codecs	SBC, apt-X
Bluetooth QD ID PX	B014795

apt-X audio coding

- Outstanding audio quality** apt-X technology is what wireless audio has been waiting for. With apt-X audio coding, you can be assured of crisp, pure and full stereo sound. It allows you to not only hear, but experience and feel the audio as it was intended. Utilizing apt-X, **Bluetooth** can now offer wireless audio quality that is indistinguishable from the highest quality wired connection.
- Professional grade sound** Until now, apt-X has been the best-kept secret of the professional audio industry. From major public broadcasters to film production studios, apt-X is used throughout the world to transmit high quality digital audio from A to Z in real-time. It was developed to meet the exacting standards of musicians and audio engineers who love the exceptional dynamic range and high fidelity it provides.
- Now available on selected consumer devices, the technology ensures that music lovers everywhere can stream the rich listening experience that only apt-X can deliver.
- Revolutionizing Bluetooth listening** **Bluetooth** technology has revolutionized our communications and lifestyle by eliminating troublesome wires and letting us get on with life “on the move”. Listening to a mobile phone conversation on a **Bluetooth** earpiece sounds just fine but when it comes to delivering full stereo sound, a little extra help is required. apt-X works within **Bluetooth** to deliver CD quality audio, ensuring you are getting the most from your wireless listening experience.
- In order to deliver two-channel digital sound within the **Bluetooth** A2DP profile, audio compression is necessary. While traditional audio compression technologies struggle to provide full-bandwidth, high-fidelity audio over **Bluetooth**, apt-X works to ensure you enjoy the fullest, richest sound your music collection has to offer.
- apt-X legacy** If you have ever been to the movies or listened to the radio then chances are you’ll already have heard apt-X in action. Over 20,000 radio stations across the world and thousands of cutting-edge film studios rely on apt-X for high quality audio delivery.
- The digital compression technology now known as apt-X was originally developed in Queen’s University, Belfast, Northern Ireland. The technology was first brought to market for radio automation applications to store CD quality audio on computer hard drives for direct playout during radio shows, hence automating the process of the disc jockey.
- The acclaim the technology received lead to further research and development and throughout the 1990s the technology was used by Broadcast and Post-production studios worldwide to deliver high-fidelity, low latency audio in situations where bandwidth was limited. The same core principles that have earned apt-X worldwide acclaim in the Broadcast and Post-Production markets make it the perfect solution for delivering high quality audio on wireless devices. apt-X is leading the way in bringing pro-audio quality to the discerning consumer.

apt-X key features:

- Blind listening tests with industry reference audiences have shown that apt-X over **Bluetooth** is indistinguishable from audio delivered over wired technology. Unlike psychoacoustic-based technologies such as MP3 or AAC, apt-X can be used to transport audio without degrading the audio quality. With MPEG/AAC compression, the encoding process is destructive and content perceived as “irrelevant” is discarded. apt-X transparent, non-destructive approach ensures that every frequency present in the original signal is preserved in the encoded and decoded signal.
- Dynamic range of > 92 dB for 16 bit audio and > 120 dB for 24 bit audio.
- The overall framework of apt-X ensures a high degree of resilience to random bit errors, with the bit error response well matched to the auditory response of the human ear. apt-X employs connection and synchronization techniques to ensure a robust connection and enable delivery of audio even under stressful conditions.
- Shortest processing delay of any professional audio compression technology. Many current wireless devices suffer from unwanted delays which cause lip-sync issues, apt-X can enable real-time delivery of wireless audio ensuring seamless integration when used with video devices.
- apt-X encoded audio fits neatly within the available bandwidth of wireless transmission standards to offer an efficient solution for bandwidth-restricted connections.

SRS WOW HD

Remarkable enhancement for mono and stereo playback

SRS WOW HD™ improves the dynamic audio performance of compressed and uncompressed audio by expanding the size of the audio image and creating a deep, rich bass response. The patented techniques in SRS WOW HD widen the horizontal sound field and raise the vertical sound image, retrieving information lost in the mixing process to create a more natural audio experience. SRS WOW HD also shapes a maximized bass response using sculpted filters and driver physics to go beyond the low-frequency limitations of speakers and headphones. SRS WOW HD also adds Definition™ Control, for realistic clarity, and the new Center Control, for dynamic extraction and positioning of dialog.

Immersive 3D audio

SRS WOW HD adjusts the space of the stereo image and eliminates the narrow stereo sweet spot and creates an immersive stereo image from mono and stereo source material. It also restores audio realism which is often masked by traditional recording and playback techniques.

Center Control

SRS WOW HD adjusts the mix of the center information into the stereo image. It works in tandem with the space control to create the perfect balance, acting as a “zoom” lens for sound. It can bring content to the fore-front to dominate the mix or fade it backward, virtually eliminating the content all together.

Optimal headphone listening

SRS WOW HD includes techniques based on patented HRTFs to deliver a natural, non-fatiguing headphone listening experience by placing the perception of the stereo sound image outside of one’s head making it more realistic and immersive.

Elevated sound image

SRS WOW HD adjusts the horizontal plane of the audio image from non-optimally placed speakers placing it at an appropriate listening level.

Definition Control

SRS WOW HD delivers a livelier, more brilliant sound. The purified sound can be heard in musical vocals, high-frequency instruments, and exposes details of ambient sound present in the audio source.

Bigger bass

SRS WOW HD includes psychoacoustic bass enhancement techniques which enhance the perception of low bass frequencies from speakers and headphones which, under normal conditions, can not produce these frequencies due to the inherent low frequency cut off and driver size limitations.

Audio level management

SRS WOW HD includes an audio level management system which monitors the output levels of the entire product audio system and manages the level dynamically to prevent sudden audio clipping.

Features of SRS WOW HD

- Stereo enhancement which improves dynamic audio performance
- Sculpted bass response for maximum thump on small speakers
- More natural audio with a wider sound field and raised sound image
- High-definition control for realistic clarity
- Center Control for dynamic extraction and positioning of dialog

Manufacturer Declarations

Warranty

Sennheiser electronic GmbH & Co. KG gives a warranty of 24 months on this product. For the current warranty conditions, please visit our website at www.sennheiser.com or contact your Sennheiser partner.

Konformitätserklärung

This product complies with the basic requirements and other relevant provisions of the following directives:

- R&TTE Directive (1999/5/EC)
- EMC Directive (2004/108/EC)
- Low Voltage Directive (2006/95/EC)
- RoHS Directive (2002/95/EC)
- WEEE Directive (2002/96/EC)
- Battery Directive (2006/66/EC)

The declarations are available on the internet at www.sennheiser.com. Before putting the devices into operation, please observe the respective country-specific regulations!

Statements regarding FCC and Industry Canada

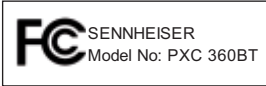
FCC Declaration of Conformity (DoC)	
We,	
	<p>Sennheiser Electronic Corporation Strat. Marketing • Stefanie Reichert One Enterprise Drive • Old Lyme • CT 06371 • USA Tel: +1 (860) 434 9190, ext. 144 Fax: +1 (860) 434 1759</p>
	declare the above device comply with the requirements of Federal Communications Commission.
	This device complies with Part 15 of the FCC rules. Operation is subjected to the following two conditions: 1) This device may not cause harmful interference, and 2) This device must accept any interference received, including interference that may cause undesired operation.
	Responsible Party: John Falcone

This device complies with Part 15 of the FCC Rules and with RSS-210 of Industry Canada. Operation is subject to the following two conditions: (1) this device may not cause harmful interference, and (2) this device must accept any interference received, including interference that may cause undesired operation.

This equipment has been tested and found to comply with the limits for a Class B digital device, pursuant to Part 15 of the FCC Rules. These limits are designed to provide reasonable protection against harmful interference in a residential installation. This equipment generates, uses and can radiate radio frequency energy and, if not installed and used in accordance with the instructions, may cause harmful interference to radio communications. However, there is no guarantee that interference will not occur in a particular installation. If this equipment does cause harmful interference to radio or television reception, which can be determined by turning the equipment off and on, the user is encouraged to try to correct the interference by one or more of the following measures:

- Reorient or relocate the receiving antenna.
- Increase the separation between the equipment and receiver.
- Connect the equipment into an outlet on a circuit different from that to which the receiver is connected.
- Consult the dealer or an experienced radio/TV technician for help.

This class B digital apparatus complies with the Canadian ICES-003.

Changes or modifications made to this equipment not expressly approved by Sennheiser electronic Corp. may void the FCC authorization to operate this equipment.

RF Radiation Exposure Information

Since the radiated output power of this Class1 BT device is far below the FCC radio frequency exposure limits, it is not subjected to routine RF exposure evaluation as per Section 2.1093 of the FCC rules.

In compliance with:

USA	FCC ID: DMOCBSSAB	
Canada	IC: 2099A – MMBTX	
Europe	  	
Australia/ New Zealand		
Singapore	Complies with IDA Standards DB100582	
Taiwan	 CCAB10LP0970T8	
Japan	 	
Russia	 ME61	
Korea	 SE9 - PXC360BT	
China	 CMIIT ID: 2010DJ1406	

Trademarks

Sennheiser and NoiseGard™ are registered trademarks of Sennheiser electronic GmbH & Co. KG.

The Bluetooth® word mark and logos are registered trademarks owned by Bluetooth SIG, Inc. and any use of such marks by Sennheiser electronics GmbH & Co. KG is under license.

iPhone® and iPod® are registered trademarks of Apple Inc, registered in the U.S. and other countries.

SRS WOW HD™ is a registered trademark of SRS Labs, Inc.

Definition™ Control is a registered trademark of SRS Labs, Inc.

apt-X® is a registered trademark of APT Ltd.



Sennheiser electronic GmbH & Co. KG
Am Labor 1, 30900 Wedemark, Germany
www.sennheiser.com

Publ. 05/10
540041/A01